

Installation instructions

i Refer to installation use and maintenance manual for more information.
Available user manual at link <http://www.everelettronica.it/manhw.html>



TITANIO
VECTOR - STEPPER - DRIVES

2 phase bipolar stepper drive technical data:

- DC power supply: 12 ± 48 Vdc
- DC logic supply: 12 ± 48 Vdc (optional and not isolated)
- Phase current: up to 6 Apeak
- Chopper frequency: ultrasonic 40KHz
- Stepless Control Technology (65536 position per turn)
- Protections against: over current, over/under voltage, overheating, short circuit between motor phase-to-phase and phase-to-ground
- Ethernet communication interface (Modbus TCP/IP protocol)
- Encoder input (not isolated): 5V Differential (RS422) or 5V Single-Ended (TTL/CMOS) incremental encoder
- Service SCI interface for programming and real time debugging
- 4 digital inputs (opto-coupled)
- 2 digital outputs (opto-coupled)
- Dimensions: 121 x 74 x 26 mm (without connectors)
- Protection degree: IP20
- Pollution degree: 2
- Category C3 following standard EN 61800-3
- Working temperature 5°C ± 40°C; Storage temperature -25°C ± 55°C
- Humidity: 5% ± 85% not condensing



Mechanical data

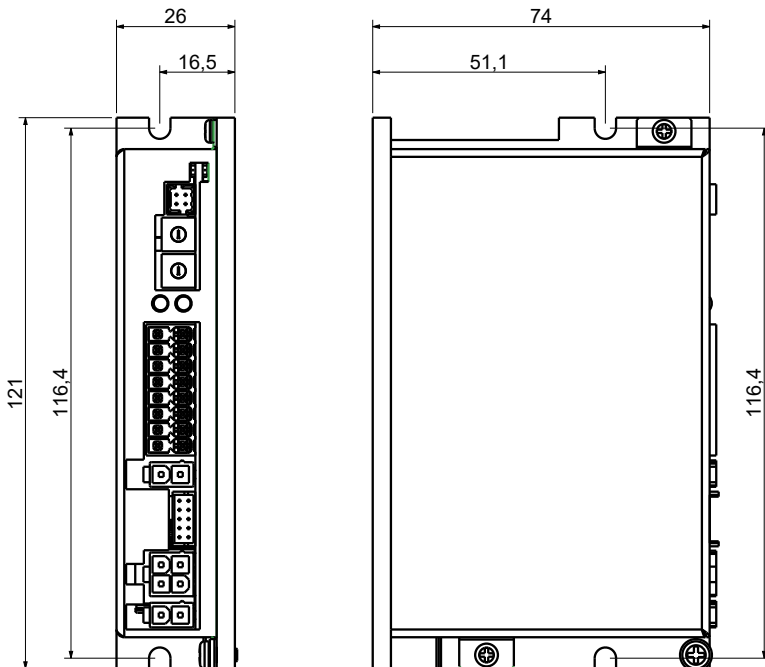

System connections

Connectors:

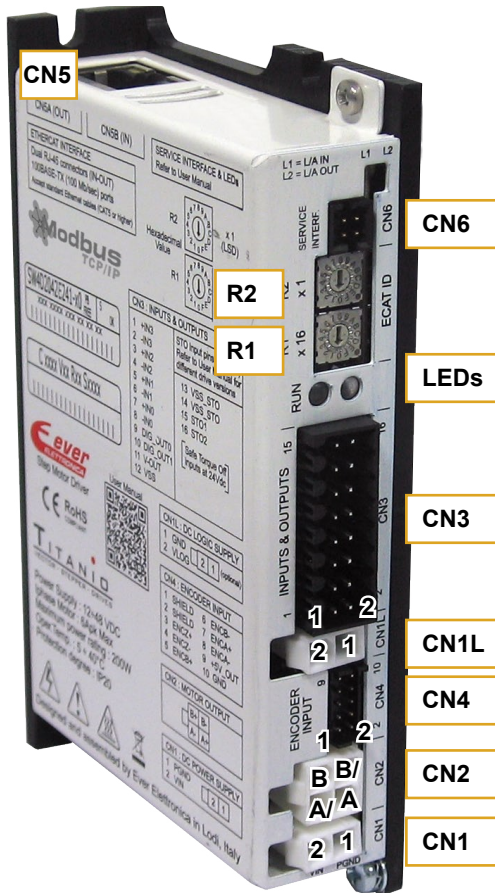

Power and Logic supplies are not isolated but they have common reference inside the drive. (GND and PGND are in common).

System connection

CN1: Power supply

2 positions, pitch 4.2mm double row, PCB header connector

CN1.1	PGND	PWR_IN	Negative DC power supply input
CN1.2	VIN	PWR_IN	Positive DC power supply input



CN2: Motor connection

4 positions, pitch 4.2mm double row, PCB header connector

CN2.1	B/	PWR_OUT	Motor output phase B/
CN2.2	A	PWR_OUT	Motor output phase A
CN2.3	B	PWR_OUT	Motor output phase B
CN2.4	A/	PWR_OUT	Motor output phase A/

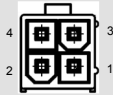

CN1L: Logic supply

2 positions, pitch 4.2mm double row, PCB header connector

CN1L.1	GND	PWR_IN	Negative DC logic supply input
CN1L.2	VLOG	PWR_IN	Positive DC logic supply input



Not isolated from the power.

CN4: Encoder input connection

10 positions, pitch 2mm double row, PCB header connector

CN4.1	SHIELD	/	Cable shield connection
CN4.2	SHIELD	/	Cable shield connection
CN4.3	ENCZ+	DIG_IN	Encoder Zero input positive
CN4.4	ENCZ-	DIG_IN	Encoder Zero input negative
CN4.5	ENCB+	DIG_IN	Encoder phase B input positive
CN4.6	ENCB-	DIG_IN	Encoder phase B input negative
CN4.7	ENCA+	DIG_IN	Encoder phase A input positive
CN4.8	ENCA-	DIG_IN	Encoder phase A input negative
CN4.9	+5V	PWR-OUT	+5Vdc power supply output
CN4.10	GND	PWR-OUT	Negative side of supply

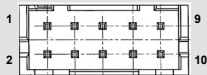

CN5: Ethernet interface

RJ45, 8 positions shielded, PCB header connector

RJ45 connector
100BASE-TX (100Mb/sec) port
Accept standard Ethernet cable (CAT5 or higher)

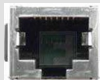

CN5

CN3: Inputs and outputs

16 positions, pitch 3.5mm double row, PCB header connector

CN3.1	+IN3	DIG_IN	Digital input 3 positive side
CN3.2	-IN3	DIG_IN	Digital input 3 negative side
CN3.3	+IN2	DIG_IN	Digital input 2 positive side
CN3.4	-IN2	DIG_IN	Digital input 2 negative side
CN3.5	+IN1	DIG_IN	Digital input 1 positive side
CN3.6	-IN1	DIG_IN	Digital input 1 negative side
CN3.7	+IN0	DIG_IN	Digital input 0 positive side
CN3.8	-IN0	DIG_IN	Digital input 0 negative side
CN3.9	DIG_OUT0	DIG_OUT	PNP digital output OUT0
CN3.10	DIG_OUT1	DIG_OUT	PNP digital output OUT1
CN3.11	V_OUT	PWR_IN	24Vdc supply for digital output
CN3.12	VSS	PWR_IN	Negative input supply for digital output
CN3.13	n.c.		Not connected
CN3.14	n.c.		Not connected
CN3.15	n.c.		Not connected
2CN3.16	n.c.		Not connected

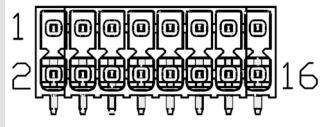

CN6: Service SCI interface

4 positions, pitch 2mm double row, PCB header connector

CN6.1	TX/RX	Transmit / Receive Line
CN6.2	DE/RE	Drive Enable Negated / Receive Enable
CN6.3	+5V	+5V power out
CN6.4	GND	DNG power out

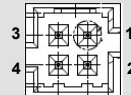

Service SCI connection



This connection is only possible with hardware and software provided by Ever.
Kit code: SW4_SERV00-SL.

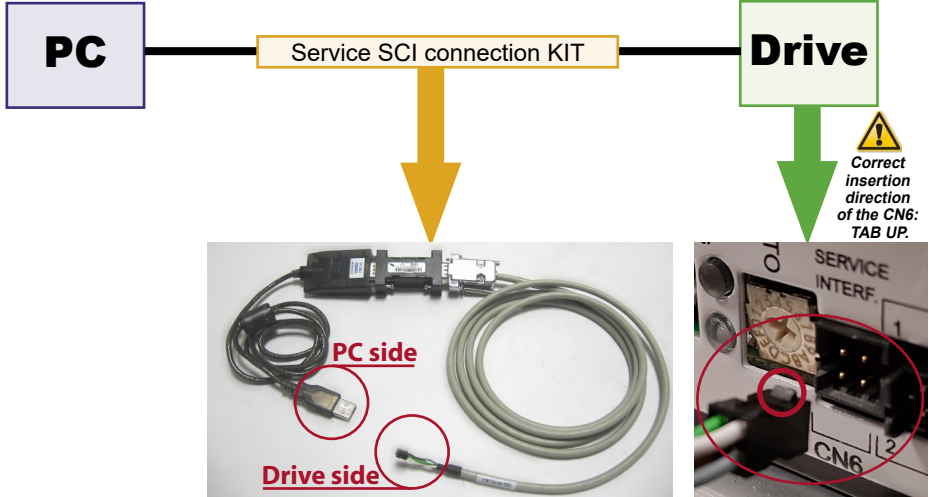

Roto-Switches settings

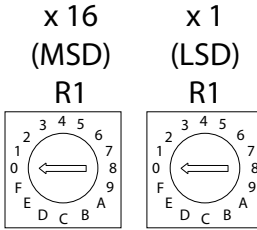

Ethernet IP Address (Last Significant Byte in Hexadecimal Value)										
R1 x 16 (MSD)	0	0	0	0	...	2	2	...	F	F
R2 x 1 (LSD)	0	1	2	3	...	C	D	...	E	F
IP ADDRESS	SW settings (default)	1	2	3	...	44	45	---	254	255

R1 (MSD): Most Significant Digit that must be multiplied per 16
R2 (LSD): Least Significant Digit that must be multiplied per 1

Example:
 R1 = 5 ----> 5 x 16 = 80
 R2 = C ----> 12 x 1 = 12
 IP Address(Least Significant Byte) = 92

Working Status (Led)

Visualization status		Description
1	Green ON	Communication Active with Master 'Operational'
2	Green Blinking	No-Communication with Master
3	Blue ON	Error: connect with Service SCI kit and check with software
4	Blue ON and Yellow ON	Drive in boot mode. A new firmware should be downloaded to drive
5	Blue ON Red Blinking (200ms)	Initialization phase. Should last few seconds. While in this condition the drive is not fully operational
6	Yellow ON Red OFF Blue OFF	Missing setting of Inominal
7	Yellow Blinking (500ms) Red OFF Blue OFF	Warning : connect with Service SCI kit and check with software
8	Red ON	Protection: Motor is in open phase condition
9	Red Blinking (200ms)	Current protection
10	Red ON (1sec) + Yellow 1 Blink	Undervoltage protection
11	Red ON (1sec) + Yellow 3 Blink	Thermal protection
12	Red ON (1sec) + Yellow 4 Blink	Motor Feedback Error
13	Red ON (1sec) + Yellow 5 Blink	Missing Safe Torque Off
14	Red ON (1sec) + Yellow 6 Blink	Motor Current Regulation is out of range
15	Red ON (1sec) + Yellow 7 Blink	e3PLC User Protection (generated by setting bit #0 of e3PLC_User_Settings)



NOTE: Drive could be considered in a correct status if leds Red, Yellow and Blue are all OFF. In general:

- Led Blue indicates a software internal fault or a non-operative condition
- Led Red indicates an alarm or a drive protection
- Led Yellow indicates a warning

Encoder input connection

Electrically NOT-isolated digital inputs :

- Differential 5Vdc that meet the RS422 standard
- Single-Ended 5Vdc TTL/CMOS

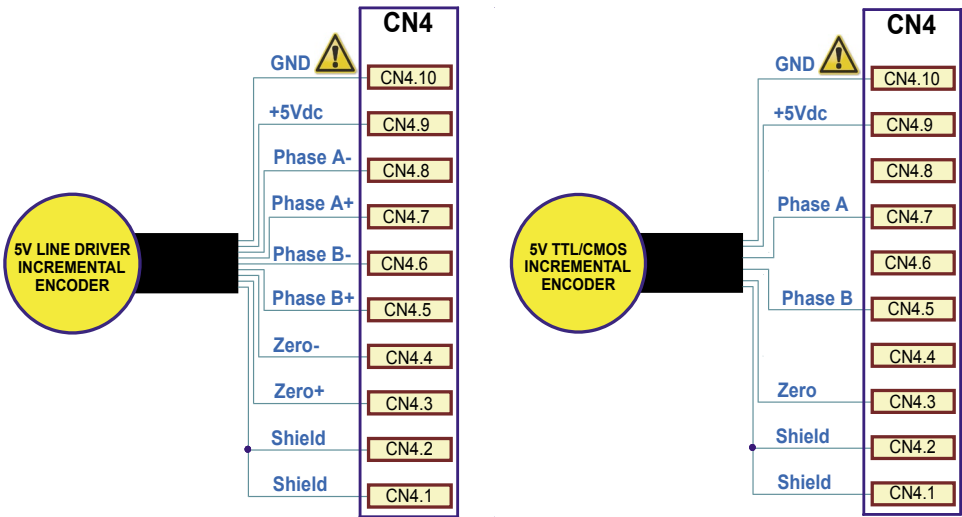

Maximum supply current 100 mA.



GND is internally in common with power ground, this is potentially dangerous. Take all necessary measures to avoid possible contacts in the final installation.

Digital inputs connection



Differential PNP, NPN and Line Driver type.

5 - 24Vdc INPUTS

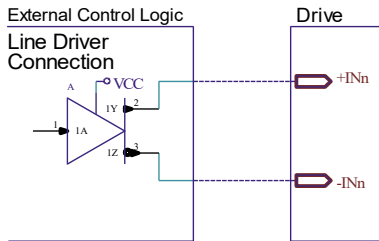
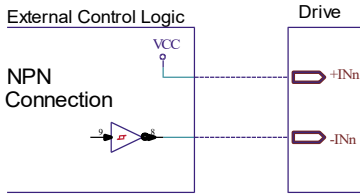
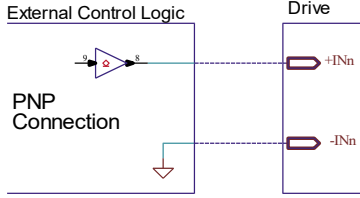

IN0 & IN1

Characteristics	MIN.	MAX.	Unit
Supply voltage	5	24	Vdc
Inputs frequency	--	10	kHz
Threshold switching voltage	1.9	2.4	Vdc
Current at 5 Vdc	--	6.28	mA
Current at 24 Vdc	--	8.75	mA

IN2 & IN3

Characteristics	MIN.	MAX.	Unit
Supply voltage	5	24	Vdc
Inputs frequency	--	250	kHz
Threshold switching voltage	1.9	2.4	Vdc
Current at 5 Vdc	--	7.52	mA
Current at 24 Vdc	--	10	mA

Digital outputs connection



Digital outputs are PNP with $V_{OUTmax} = 24$ Vdc, $I_{OUTmax} = 100$ mA, $F_{max} = 40$ kHz.

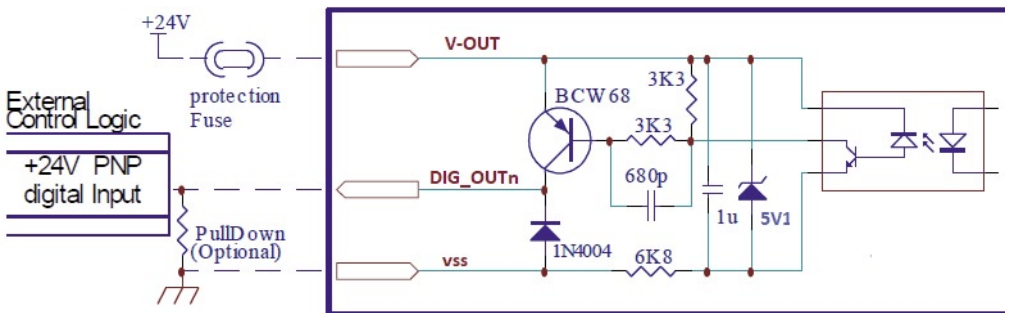

Mating connectors

Connector	Description
CN1	Molex 39-01-2025
CN1L	Molex 39-01-2025
CN2	Molex 39-01-2045
CN3	Weidmuller 1727690000
CN4	Hirose DF11-10DS-2C
CN5	Ethernet standard cables (CAT5 or higher)

Section of the cables

Function	Cable	
	Minimum	Maximum
Power supply and PE	0.5 mm ² (AWG20)	1.3 mm ² (AWG16)
Motor outputs	0.5 mm ² (AWG20)	1.3 mm ² (AWG16)
Encoder input	0.08 mm ² (AWG28)	0.2 mm ² (AWG24)
Inputs and Outputs	0.2 mm ² (AWG24)	1.3 mm ² (AWG16)
EtherCAT interfaces	Ethernet standard cables (CAT5 or higher)	

Verify the installation

- Check all connection: power supply and inputs/outputs.
- Make sure all settings right for the application.
- Make sure the power supply is suitable for the drive.
- If possible, remove the load from the motor shaft to avoid that wrong movements cause damage.
- Enable the current to the motor and verify the applied torque.
- Enable a movement of some steps and verify if the rotation direction is the desired one.
- Disconnect the power supply, connect the load on the motor and check the full functionality.

Analysis of malfunctions



When any of the following situations occur, the drive is placed in a fault condition.

DEFECT	CAUSE	ACTION
Intervention of the thermal protection.	Can be caused by a heavy working cycle or a high current in the motor.	Improve the drive cooling by a natural or fan air flow. Consider to use a motor with a higher torque vs current rating.
Intervention of the current protection.	Short circuit on the motor powering stage(s) of the drive.	Check motor windings and cables to remove the short circuits replacing faulty cables or motor if necessary.
Intervention of the over/under voltage protection	Supply voltage out of range.	Check the value for the supply voltage.
Open phase motor protection.	Motor windings to drive not proper connection.	Check motor cables and connections to the drive.



When any of the following situations occur, the drive doesn't work and isn't placed in an error condition.

DEFECT	CAUSE	ACTION
Noisy motor movement with vibrations.	Can be caused by a lack of power supply to a phase of the motor or a poor regulation of the winding currents.	Check the cables and connections of the motor and/or change the motor speed to avoid a resonance region.
The external fuse on the power supply of the drive is burned.	Can be caused by a wrong connection of the power supply.	Connect the power supply correctly and replace the fuse.
At high speed, the motor torque is not enough.	Can be due to a 'self-limitation' of motor current and torque.	Increase the motor current (always within the limits), increase the supply voltage, change motor connection from series to parallel.

EVER Elettronica

Via del Commercio, 2/4 - 9/11

Loc. San Grato Z. I

26900 - L O D I - Italy

Phone +39 0371 412318 - Fax +39 0371 412367

email: infoever@everelettronica.it

web: www.everelettronica.it

