

Installation instructions

i Refer to installation use and maintenance manual for more information.
Available user manual at link <http://www.everelettronica.it/manhw.html>



2 phase bipolar stepper drive technical data:

- AC power supply: 18 ± 56 Vac
- DC logic supply: 24 Vdc (optional and not isolated)
- Phase current: up to 10 Apeak
- Chopper frequency: ultrasonic 40KHz
- Stepless Control Technology (65536 position per turn)
- Protections against: over current, over/under voltage, overheating, short circuit between motor phase-to-phase and phase-to-ground
- EtherCAT communication interfaces
- Absolute Encoder (not isolated): 5V BiSS-C or SSI encoder interface
- Service SCI interface for programming and real time debugging
- 4 digital inputs (opto-coupled)
- 2 digital outputs (opto-coupled)
- Dimensions: 148.8 x 82 x 30 mm (without connectors)
- Protection degree: IP20
- Pollution degree: 2
- Category C3 following standard EN 61800-3
- Working temperature 5°C ± 40°C; Storage temperature -25°C ± 55°C
- Humidity: 5% ± 85% not condensing

TITANIO
VECTOR - STEPPER - DRIVES

EtherCAT 



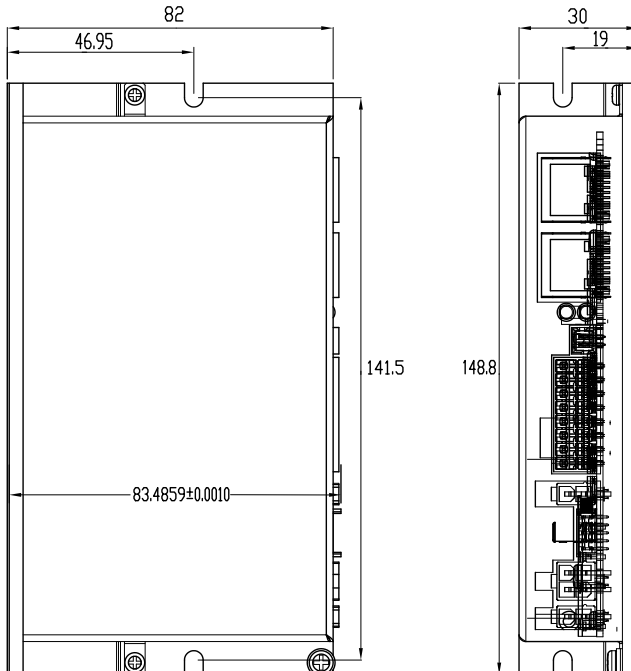

Mechanical data

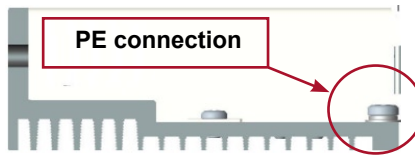
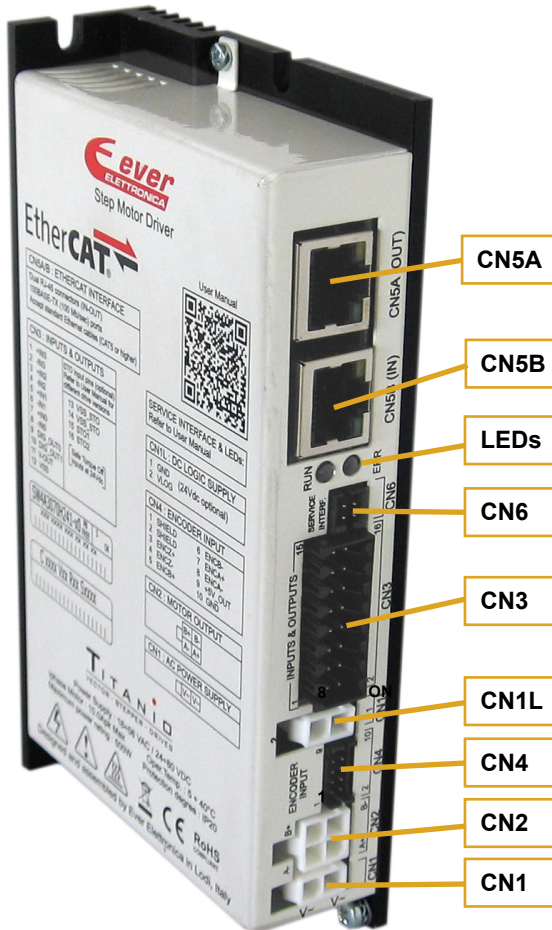

System connections

Connectors:



-  ***Power and Logic supplies are not isolated but they have common reference inside the drive.***
-  ***Use two separate and isolated supply for logic and digital outputs.***
-  ***Connect GND of the logic supply and VSS of the output supply to PE near to the origin of the supplies with two different wires.***
-  ***Do not connect simultaneously PE to the secondary circuit of the power transformer and to GND of the logic supply, otherwise the drive breaks and becomes unusable.***

System connection

CN1: Power supply

2 positions, pitch 4.2mm double row, PCB header connector

CN1.1	ACin	PWR_IN	AC power supply input
CN1.2	ACin	PWR_IN	AC power supply input



CN2: Motor connection

4 positions, pitch 4.2mm double row, PCB header connector

CN2.1	B/	PWR_OUT	Motor output phase B/
CN2.2	A	PWR_OUT	Motor output phase A
CN2.3	B	PWR_OUT	Motor output phase B
CN2.4	A/	PWR_OUT	Motor output phase A/

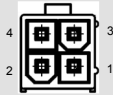

CN1L: Logic supply

2 positions, pitch 4.2mm double row, PCB header connector

CN1L.1	GND	PWR_IN	Negative DC logic supply input
CN1L.2	VLOG	PWR_IN	Positive DC logic supply input



Not isolated from the power.

CN4: Absolute Encoder interface

10 positions, pitch 2mm double row, PCB header connector

CN4.1	SHIELD	/	Cable shield connection
CN4.2	SHIELD	/	Cable shield connection
CN4.3	N.C.		Not connected
CN4.4	N.C.		Not connected
CN4.5	E_DATA+	DIG_IN	Serial Data input positive
CN4.6	E_DATA-	DIG_IN	Serial Data input negative
CN4.7	E_CLK+	DIG_OUT	Serial Clock output positive
CN4.8	E_CLK-	DIG_OUT	Serial Clock output negative
CN4.9	+5V	PWR-OUT	+5Vdc power supply output
CN4.10	GND	PWR-OUT	Negative side of supply

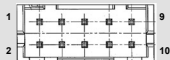

CN5A e CN5B: EtherCAT interface

RJ45, 8 positions shielded, PCB header connector

Dual RJ45 connectors (IN-OUT)
100BASE-TX (100Mb/sec) ports
Accept standard Ethernet cable (CAT5 or higher)

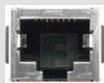

CN5B (IN)

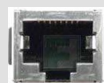

CN5A (OUT)

CN3: Inputs and outputs

26 positions, pitch 2mm double row, PCB header connector

CN3.1	+IN3	DIG_IN	Digital input 3 positive side
CN3.2	-IN3	DIG_IN	Digital input 3 negative side
CN3.3	+IN2	DIG_IN	Digital input 2 positive side
CN3.4	-IN2	DIG_IN	Digital input 2 negative side
CN3.5	+IN1	DIG_IN	Digital input 1 positive side
CN3.6	-IN1	DIG_IN	Digital input 1 negative side
CN3.7	+IN0	DIG_IN	Digital input 0 positive side
CN3.8	-IN0	DIG_IN	Digital input 0 negative side
CN3.9	DIG_OUT0	DIG_OUT	PNP digital output OUT0
CN3.10	DIG_OT1	DIG_OUT	PNP digital output OUT1
CN3.11	V_OUT	PWR_IN	24Vdc supply for digital
CN3.12	VSS	PWR_IN	Negative input supply for digital
CN3.13	n.c.		Not connected
CN3.14	n.c.		Not connected
CN3.15	n.c.		Not connected
2CN3.16	n.c.		Not connected

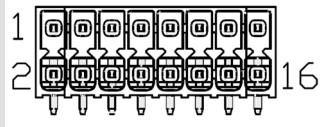

CN6: Service SCI interface

4 positions, pitch 2mm double row, PCB header connector

CN6.1	TX/RX	Transmit / Receive Line
CN6.2	DE/RE	Drive Enable Negated / Receive Enable
CN6.3	+5V	+5V power out
CN6.4	GND	DNG power out

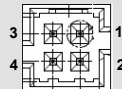

Working Status (Led)

	Visualization status	Description
1	✗	Green OFF
2	●	Green ON
3	●	Green Blinking
4	●	Green Single Flash
5	●	Blue ON
6	●	Blue ON and Yellow ON
8	●	Blue ON Red Blinking (200ms)
9	●	Yellow ON Red OFF Blue OFF
10	●	Yellow Blinking (500ms) Red OFF Blue OFF
11	●	Red ON
12	●	Red Blinking (200ms)
13	●	Red ON (1sec) + Yellow 1 Blink
15	●	Red ON (1sec) + Yellow 3 Blink
16	●	Red ON (1sec) + Yellow 4 Blink
17	●	Red ON (1sec) + Yellow 5 Blink
18	●	Red ON (1sec) + Yellow 6 Blink
19	●	Red ON (1sec) + Yellow 7 Blink



NOTE: Drive could be considered in a correct status if leds Red, Yellow and Blue are all OFF. In general:

- Led Blue indicates a software internal fault or a non-operative condition
- Led Red indicates an alarm or a drive protection
- Led Yellow indicates a warning

Service SCI connection



This connection is only possible with hardware and software provided by Ever.
Kit code: SW4_SERV00-SL or SW4-SERV00-EE.

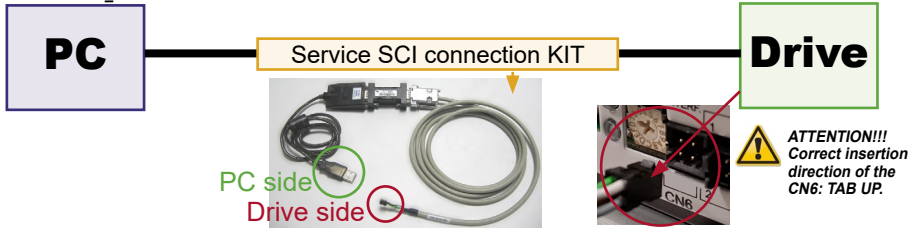

Absolute Encoder interface connection

Electrically NOT-isolated 5V RS485 Full-Duplex interface

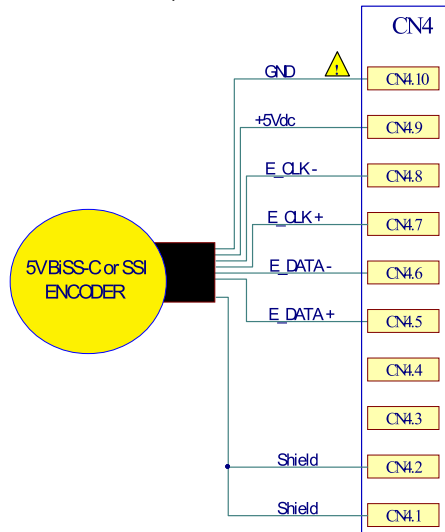

Maximum supply current 100 mA.



GND is internally in common with power ground, this is potentially dangerous. Take all necessary measures to avoid possible contacts in the final installation.

Digital inputs connection



Differential PNP, NPN and Line Driver type.

3.3 - 24V INPUT

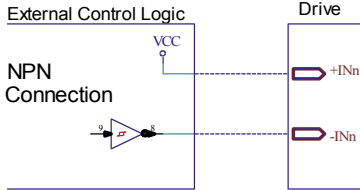
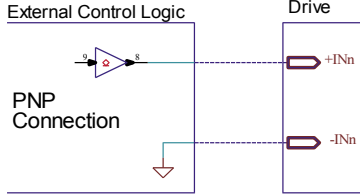

2 - 24V INPUT

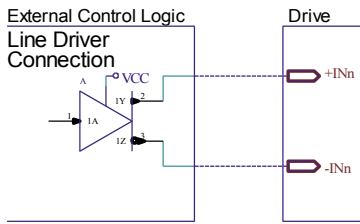

Characteristics	MIN.	MAX.	Unit
Supply voltage	2 ⁽¹⁾	24	Vdc
Inputs frequency	--	1	Mhz
Threshold switching voltage	1.61 ⁽¹⁾	--	Vdc
Current at 2 Vdc	--	2.53	mA
Current at 3.3 Vdc	--	5.84	mA
Current at 5 Vdc	--	6.28	mA
Current at 24 Vdc	--	8.75	mA

(1) N.B.: it's recommended to use 2 Vdc digital inputs only in differential Line-Driver configuration to have more noise immunity.

Digital outputs connection



Digital outputs are PNP with $V_{OUTmax} = 24$ Vdc, $I_{OUTmax} = 100$ mA, $F_{max} = 500$ KHz.

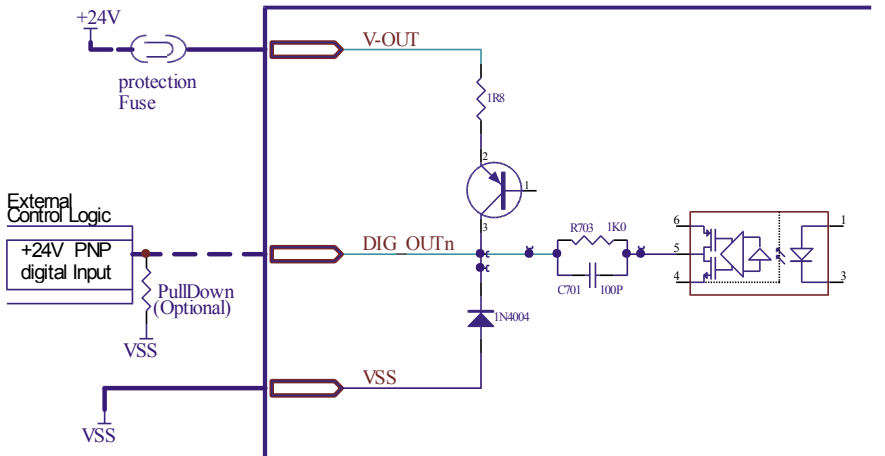

Mating connectors

Connector	Description
CN1	Molex 39-01-2025
CN1L	Molex 39-01-2025
CN2	Molex 39-01-2045
CN3	Weidmuller 1727690000
CN4	Hirose DF11-10DS-2C
CN5A / CN5B	Ethernet standard cables (CAT5 or higher)

Section of the cables

Function	Cable	
	Minimum	Maximum
Power supply and PE	0.5 mm ² (AWG20)	1.3 mm ² (AWG16)
Motor outputs	0.5 mm ² (AWG20)	1.3 mm ² (AWG16)
Encoder input	0.08 mm ² (AWG28)	0.2 mm ² (AWG24)
Inputs and Outputs	0.2 mm ² (AWG24)	1.3 mm ² (AWG16)
EtherCAT interfaces	Ethernet standard cables (CAT5 or higher)	

Verify the installation

- Check all connection: power supply and inputs/outputs.
- Make sure all settings right for the application.
- Make sure the power supply is suitable for the drive.
- If possible, remove the load from the motor shaft to avoid that wrong movements cause damage.
- Enable the current to the motor and verify the applied torque.
- Enable a movement of some steps and verify if the rotation direction is the desired one.
- Disconnect the power supply, connect the load on the motor and check the full functionality.

Analysis of malfunctions



When any of the following situations occur, the drive is placed in a fault condition.

DEFECT	CAUSE	ACTION
Intervention of the thermal protection.	Can be caused by a heavy working cycle or a high current in the motor.	Improve the drive cooling by a natural or fan air flow. Consider to use a motor with a higher torque vs current rating.
Intervention of the current protection.	Short circuit on the motor powering stage(s) of the drive.	Check motor windings and cables to remove the short circuits replacing faulty cables or motor if necessary.
Intervention of the over/under voltage protection	Supply voltage out of range.	Check the value for the supply voltage.
Open phase motor protection.	Motor windings to drive not proper connection.	Check motor cables and connections to the drive.



When any of the following situations occur, the drive doesn't work and isn't placed in an error condition.

DEFECT	CAUSE	ACTION
Noisy motor movement with vibrations.	Can be caused by a lack of power supply to a phase of the motor or a poor regulation of the winding currents.	Check the cables and connections of the motor and/or change the motor speed to avoid a resonance region.
The external fuse on the power supply of the drive is burned.	Can be caused by a wrong connection of the power supply.	Connect the power supply correctly and replace the fuse.
At high speed, the motor torque is not enough.	Can be due to a 'self-limitation' of motor current and torque.	Increase the motor current (always within the limits), increase the supply voltage, change motor connection from series to parallel.

EVER Elettronica

Via del Commercio, 2/4 - 9/11

Loc. San Grato Z. I

26900 - L O D I - Italy

Phone +39 0371 412318 - Fax +39 0371 412367

email: infoever@everelettronica.it

web: www.everelettronica.it

