

Installation instructions

i Refer to installation use and maintenance manual for more information.
Available user manual at link <http://www.everelettronica.it/manhw.html>



2 Axis bipolar stepper drive technical data:

- DC Supply: 24 ÷ 48 Vdc
- Phase current: up to 4.2 Apeak for each motor
- Chopper frequency: ultrasonic 40 kHz
- Stepless Control Technology (65536 position per turn)
- Protections against: over current, over/under voltage, overheating, short circuit between motor phase-to-phase and phase-to-ground
- Industrial Ethernet interfaces: Powerlink or EtherCAT or Modbus TCP/IP or Profinet (see ordering code)
- Incremental Encoder (not isolated): 24V Sink or 5V Single-Ended (TTL/CMOS) (see ordering code)
- Service SCI interface for programming and real time debugging
- Dimensions: 98.6 x 84.4 x 44 mm (without connectors)
- Protection degree: IP65
- Pollution degree: 2
- Category C3 following standard EN 61800-3
- Working temperature: 5°C ÷ 40°C
- Storage temperature: -25°C ÷ 55°C
- Humidity: 5% ÷ 85% not condensing

TITANIO
VECTOR - STEPPER - DRIVES



error less servo efficient
else technology[®]
by Ever Elettronica

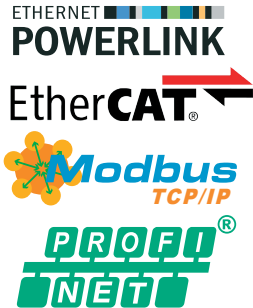

Mechanical data

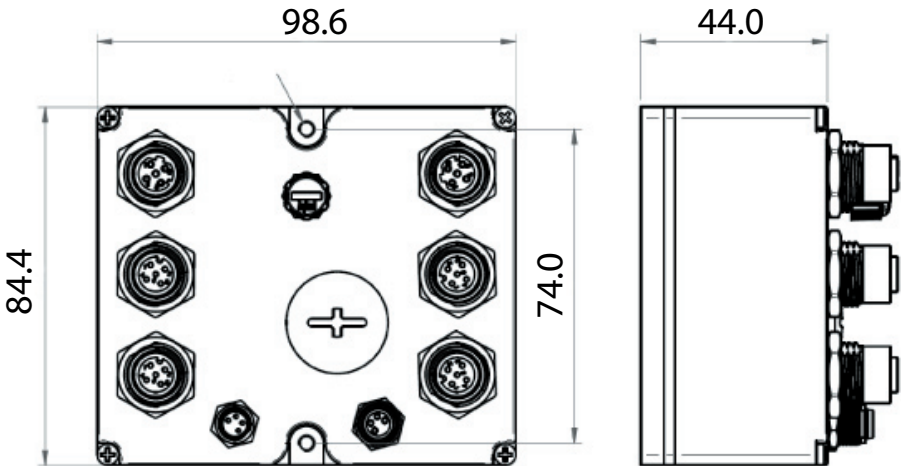

Available models

System code	Industrial ethernet interfaces	Incremental encoder type
SN4D2030R202-00	Powerlink	24V Sink
SN4D2030R202-01		5V Single-Ended (TTL/CMOS)
SN4D2030H202-00	EtherCAT	24V Sink
SN4D2030H202-01		5V Single-Ended (TTL/CMOS)
SN4D2030E202-00	Modbus TCP/IP	24V Sink
SN4D2030E202-01		5V Single-Ended (TTL/CMOS)
SN4D2030T202-00	Profinet	24V Sink
SN4D2030T202-01		5V Single-Ended (TTL/CMOS)

System connections

Connectors:

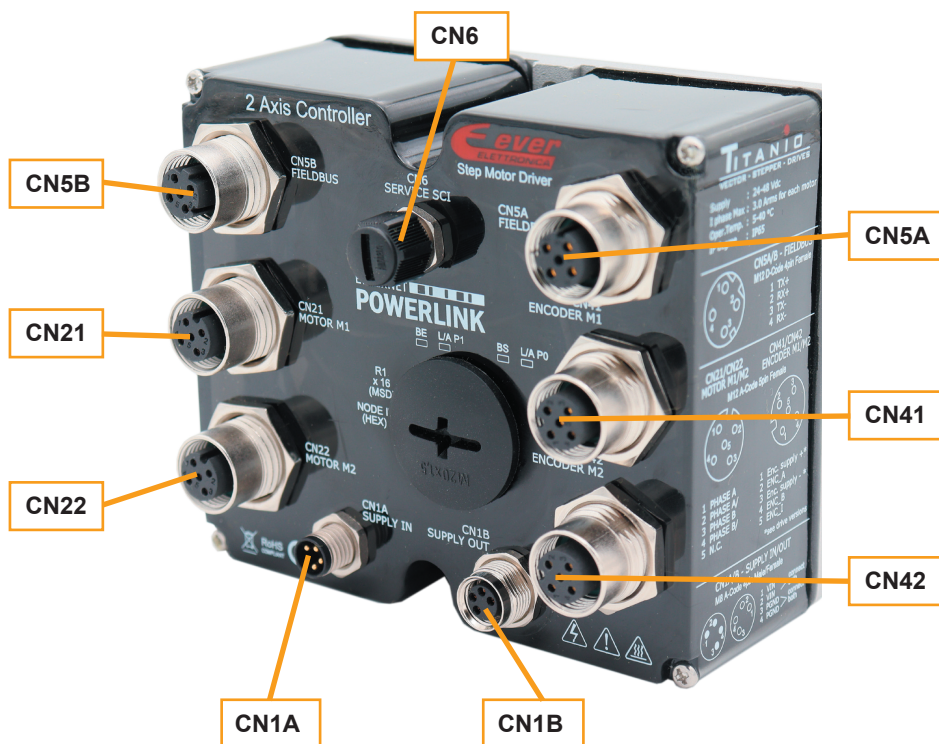

Since electromagnetic disturbances are deflected via the base plate on the back, it is important to ensure that the mounting location has good conductivity. The mounting location must also be connected with ground potential with good conductivity.



The supply is connected using circular connectors (M8, 4-pin). The supply is connected via connector CN1A (male). Connector CN1B (female) is used to route the supply to other modules. The maximum permissible current per pin is 4 A (in summation 8 A).

System connection

CN1A: Power supply IN

M8 A-Code 4 pins Male

CN1A.1	VIN	PWR_IN	Positive DC power supply input
CN1A.2	VIN		BOTH PINS MUST BE CONNECTED
CN1A.3	PGND	PWR_IN	Negative DC power supply input
CN1A.4	PGND		BOTH PINS MUST BE CONNECTED

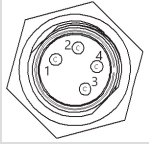

Note : VIN and PGND are each available in two terminal. **Make sure that both terminal are connected in order to split the supply current in two terminal and thereby avoid an overload of the connector.**

CN1B: Power supply OUT

M8 A-Code 4 pins Female

CN1B.1	VIN	PWR_OUT	Positive DC power supply output
CN1B.2	VIN		BOTH PINS MUST BE CONNECTED
CN1B.3	PGND	PWR_OUT	Negative DC power supply output
CN1B.4	PGND		BOTH PINS MUST BE CONNECTED

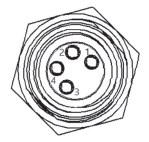

Note : VIN and PGND are each available in two terminal. **Make sure that both terminal are connected in order to split the supply current in two terminal and thereby avoid an overload of the connector.**

CN5A and CN5B: Industrial ethernet interface

100 BASE-TX (100Mb/sec) ports

Dual M12 D-Code 4 pins Female (P0-P1)

CN5x.1	TD+	DIG_OUT	Transmit Data +
CN5x.2	RD+	DIG_IN	Receive Data +
CN5x.3	TD-	DIG_OUT	Transmit Data -
CN5x.4	RD-	DIG_IN	Receive Data -

Housing Connected to base plate

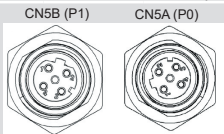

CN6: Service SCI interface

M8 A-Code 4 pins Male

CN6.1	GND	GND Power out
CN6.2	+5L	+5V power out
CN6.3	DE/RE	Drive Enable Negated / Receive Enable
CN6.4	TX/RX	Transmit / Receive Line



CN21: Motor M1 connection

M12 A-Code 5 pins Female

CN21.1	Phase A	PWR_OUT	Motor M1 output phase A
CN21.2	Phase A/	PWR_OUT	Motor M1 output phase A/
CN21.3	Phase B	PWR_OUT	Motor M1 output phase B
CN21.4	Phase B/	PWR_OUT	Motor M1 output phase B/
CN21.5	N.C.		Not connected

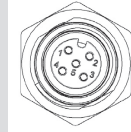

CN22: Motor M2 connection

M12 A-Code 5 pins Female

CN22.1	Phase A	PWR_OUT	Motor M2 output phase A
CN22.2	Phase A/	PWR_OUT	Motor M2 output phase A/
CN22.3	Phase B	PWR_OUT	Motor M2 output phase B
CN22.4	Phase B/	PWR_OUT	Motor M2 output phase B/
CN22.5	N.C.		Not connected

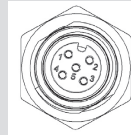

CN41: Encoder M1 input

M12 A-Code 5 pins Female

	24 V Sink version	5 V Single-Ended version
CN41.1	+24 Vdc	+5 Vdc
CN41.2		ENCA
CN41.3		GND
CN41.4		ENCB
CN41.5		ENCC

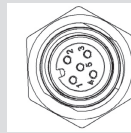

CN42: Encoder M2 input

M12 A-Code 5 pins Female

	24 V Sink version	5 V Single-Ended version
CN42.1	+24 Vdc	+5 Vdc
CN42.2		ENCA
CN42.3		GND
CN42.4		ENCB
CN42.5		ENCC

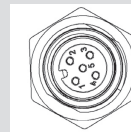

Service SCI connection



This connection is only possible with hardware and software provided by Ever.
Kit code: SN4D_SERV00-EE.

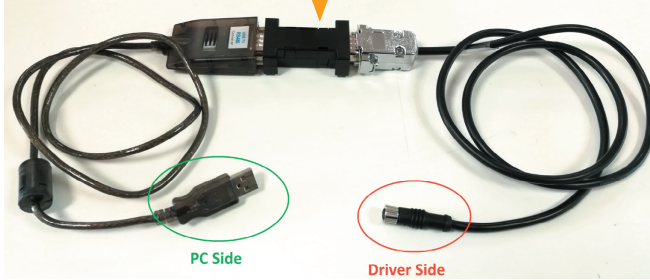

Roto-Switches settings

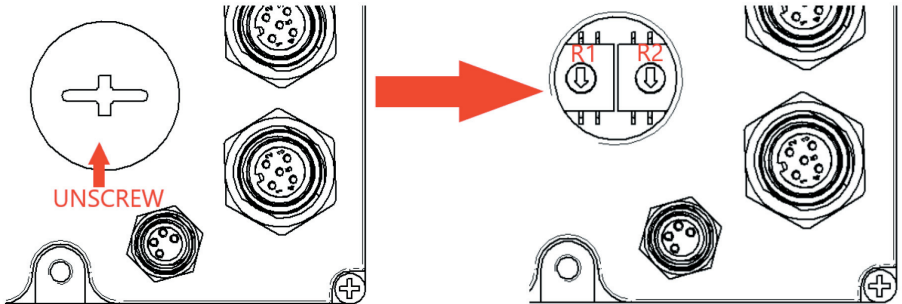

Node ID Selection (Hexadecimal Value)											
R1 x 16 (MSD)	0	0	0	0	...	2	2	...	F	F	
R2 x 1 (LSD)	0	1	2	3	...	C	D	...	E	F	
NODE ID #	SW settings (default)		1	2	3	...	44	45	...	254	255

x 16
(MSD)
R1

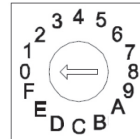

x 1
(LSD)
R2

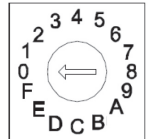

R1 (MSD): Most Significant Digit that must be multiplied per 16
R2 (LSD): Least Significant Digit that must be multiplied per 1

Example: 5C
R1 = 5 ----> 5 x 16 = 80
R2 = C ----> 12 x 1 = 12
Node ID = 92



Node-ID selection from Roto-Switches are not used in all industrial ethernet protocol.
Refer to the software manual for more details.

Leds description

The meaning of LED's is defined by the industrial ethernet protocol used ([see ordering code](#)). Refer to software manual for more details.

Led name	Powerlink	EtherCAT	Modbus TCP/IP	Profinet
COM0	BS - Green	RUN - Green	RUN - Green	SF - Red
COM1	BE - Red	ERR - Red	ERR - Red	BF - Red
P0	L/A P0 - Green	L/A IN - Green	LINK - Green ACT - Yellow	LINK - Green RX/TX - Yellow
P1	LA/P1 - Green	L/A OUT - Green	LINK - Green ACT - Yellow	LINK - Green RX/TX - Yellow

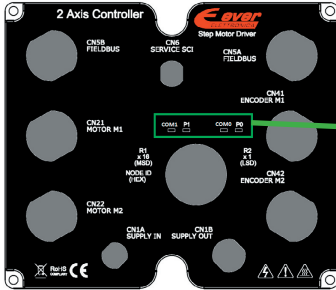

Encoder input connection (NOT isolated)

24V Sink or Single-Ended 5 Vdc TTL/CMOS ([see the ordering codes](#))

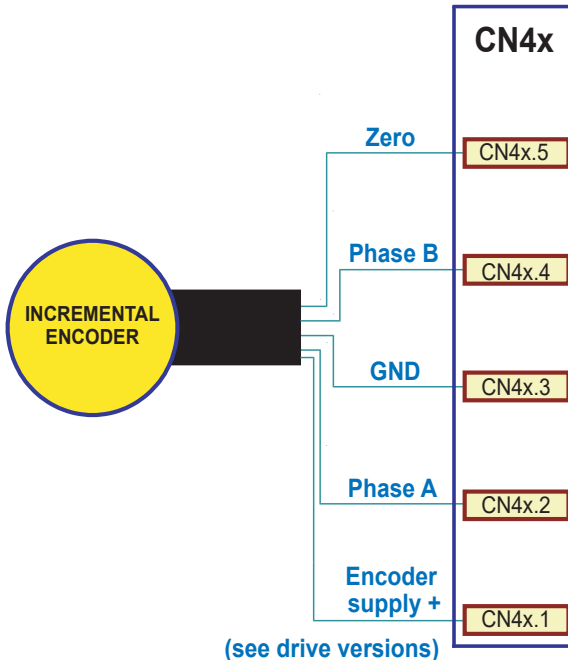

Maximum supply current 20 mA for each encoder (24V version).
Maximum supply current 100 mA for each encoder (5V version).

Mating cables kit

Connector	Connetor type	Ever code	Characteristics	Pinout	
CN1A	M8 A-Code 4 pins Female	CA/LTW0804BF01	Length : 1 mt. Conductors : UL2464 AWG#22 Jacket : Black PVC Waterproof rate: IP67	Pin #	Cable color
				1	Brown
				2	White
				3	Blue
CN1B	M8 A-Code 4 pins Male	CA/LTW0804BM01	Length : 1 mt. Conductors : UL2464 AWG#22 Jacket : Black PVC Waterproof rate: IP67	Pin #	Cable color
				1	Brown
				2	White
				3	Blue
CN21	M12 A-Code 5 pins Male	CA/LTW1205BM01	Length : 1 mt. Conductors : UL2517 AWG#22 Jacket : Black PVC Waterproof rate: IP68	Pin #	Cable color
				1	Brown
				2	White
				3	Blue
CN22	M12 A-Code 5 pins Male	CA/LTW1205BM01	Length : 1 mt. Conductors : UL2517 AWG#22 Jacket : Black PVC Waterproof rate: IP68	Pin #	Cable color
				4	Black
				5	Grey
				Pin #	Cable color
CN41	M12 A-Code 5 pins Male	CA/LTW1205BM01	Length : 1 mt. Conductors : UL2517 AWG#24 Jacket : Black PVC Waterproof rate: IP68	1	Brown
				2	White
				3	Blue
				4	Black
CN41	M12 A-Code 5 pins Male	CA/LTW1205BM01	Length : 1 mt. Conductors : UL2517 AWG#24 Jacket : Black PVC Waterproof rate: IP68	5	Grey
				Pin #	Cable color
				1	Brown
				2	White
CN5A	M12 D-Code 4 pins Male Shielded	CA/LTW1204BMD01	Length : 1 mt. Conductors : UL2517 AWG#22 Jacket : Black PVC Waterproof rate: IP68	3	Blue
				4	Black
				Pin #	Cable color
				4	Black

Verify the installation

- Check all connection: power supply and inputs/outputs.
- Make sure all settings right for the application.
- Make sure the power supply is suitable for the drive.
- If possible, remove the load from the motor shaft to avoid that wrong movements cause damage.
- Enable the current to the motor and verify the applied torque.
- Enable a movement of some steps and verify if the rotation direction is the desired one.
- Disconnect the power supply, connect the load on the motor and check the full functionality.

Analysis of malfunctions



When any of the following situations occur, the drive is placed in a fault condition.

DEFECT	CAUSE	ACTION
Intervention of the thermal protection.	Can be caused by a heavy working cycle or a high current in the motor.	Improve the drive cooling by a natural or fan air flow. Consider to use a motor with a higher torque vs current rating.
Intervention of the current protection.	Short circuit on the motor powering stage(s) of the drive.	Check motor windings and cables to remove the short circuits replacing faulty cables or motor if necessary.
Intervention of the over/under voltage protection	Supply voltage out of range.	Check the value for the supply voltage.
Open phase motor protection.	Motor windings to drive not proper connection.	Check motor cables and connections to the drive.



When any of the following situations occur, the drive doesn't work and isn't placed in an error condition.

DEFECT	CAUSE	ACTION
Noisy motor movement with vibrations.	Can be caused by a lack of power supply to a phase of the motor or a poor regulation of the winding currents.	Check the cables and connections of the motor and/or change the motor speed to avoid a resonance region.
The external fuse on the power supply of the drive is burned.	Can be caused by a wrong connection of the power supply.	Connect the power supply correctly and replace the fuse.
At high speed, the motor torque is not enough.	Can be due to a 'self-limitation' of motor current and torque.	Increase the motor current (always within the limits), increase the supply voltage, change motor connection from series to parallel.

EVER Elettronica
Via del Commercio, 2/4 - 9/11
Loc. San Grato Z. I
26900 - L O D I - Italy
Phone +39 0371 412318 - Fax +39 0371 412367
email: infoever@everelettronica.it
web: www.everelettronica.it

